

Sliding Door Rail Holder To Glass - Flat Hole (Model: KGSD151F)

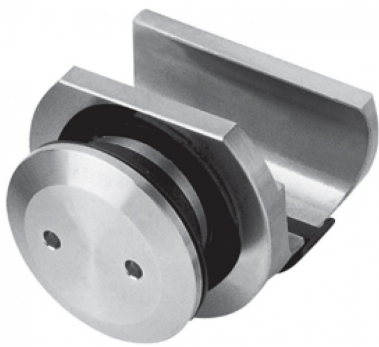

- Suitable for mounting the sliding door rail on to glass fixed panels.
- Suitable for 10mm to 12mm thick glass.
- The countersunk option means that the fitting finishes flush with the glass surface.

Attributes:

Product Code: KGSD151F

Unit Of Sale: Each

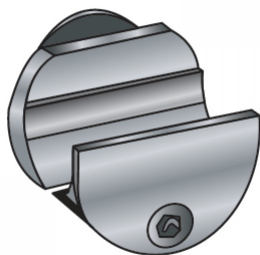
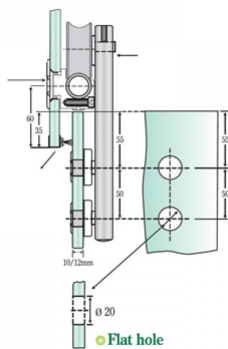

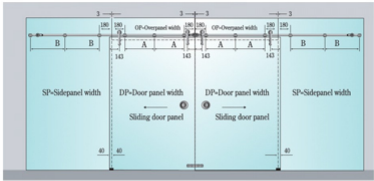
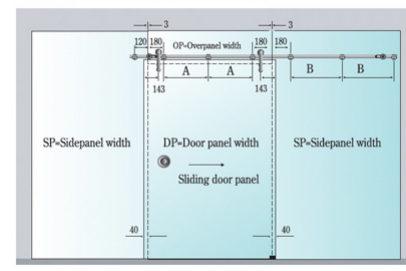
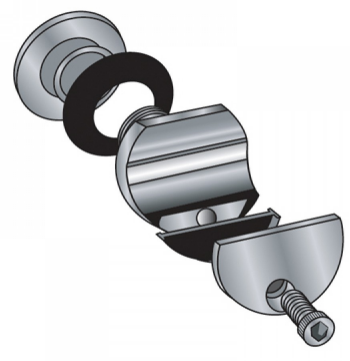
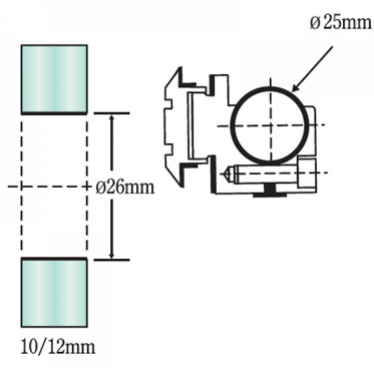

$A = [OP - (180 + 180)] \div 2$ OP = Overpanel width
 $B = [SP - (180 + 180)] \div 2$ SP = Sidepanel width
 DP = Door panel width