

Glass Clamp - 63x45mm - 316SSS - Satin - 48mm Tube - 6-12mm ( Model: K.GC.6345.316.048.S )

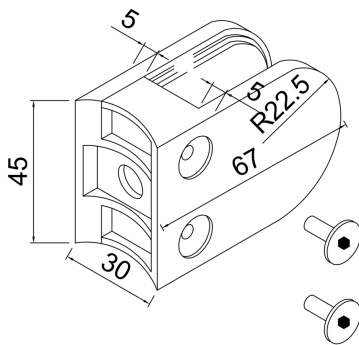

- A 63mm x 45mm D shaped clamp. Suitable for mounting to a 48mm diameter post.
- Used mainly indoors for stairs, glass balconies, counter dividers, retail glass displays and splash guards.
- Supplied with an optional anti-slip safety pin which allows you to drill the glass to ensure that it never slips downwards over time.
- These clamps are suitable for loads up to approximately 34kgs per four clamps.
- Available in [304 grade satin \(brushed\) stainless steel](#) and [316 grade polished stainless steel](#).



**Attributes:**

**Product Code:** K.GC.6345.316.048.S

**Unit Of Sale:** Each

