

Glass Clamp - 63x45mm - 304SSS - Satin - Flat - 6-12mm Glass (Model: K.GC.6345.304.000.S)

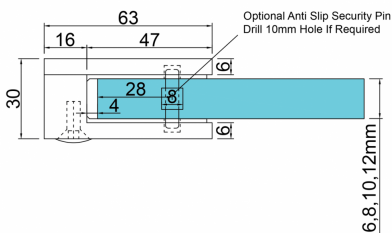
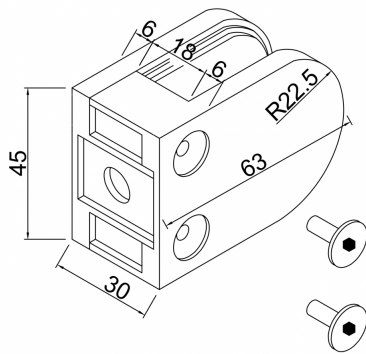

- A 63mm x 45mm D shaped clamp. Suitable for mounting on a flat surface.
- For stairs, glass balconies, counter dividers, retail glass displays and splash guards.
- Supplied with an optional anti-slip safety pin which allows you to drill the glass to ensure that it never slips downwards over time.
- These clamps are suitable for glass panels weighing up to approximately 34kgs per four clamps.
- Also available in [316 grade satin \(brushed\) stainless steel](#) and [316 grade polished stainless steel \(mirror finished\)](#).

Attributes:

Product Code: K.GC.6345.304.000.S

Unit Of Sale: Each

