

Glass Clamp - 45x45mm - 316SSS - Satin - 48mm Tube - 6-10mm (Model: K.GC.4545.316.048.S)

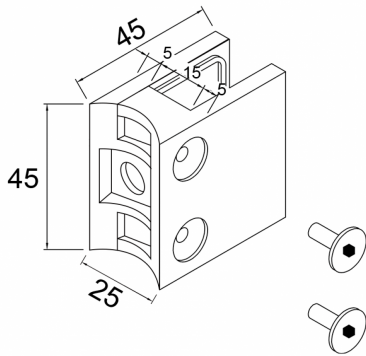

- A 45mm x 45mm square shaped clamp.
- Suitable for mounting on a 48mm diameter post.
- For stairs, counter dividers, desk dividers and retail glass splash guards.
- These clamps are suitable for loads up to approximately 20kgs per four clamps.
- Also available in [304 grade satin \(brushed\) stainless steel](#).



Attributes:

Product Code: K.GC.4545.316.048.S

Unit Of Sale: Each

